

 **APELEM**

PRESENTS

R/F

SOLUTIONS



PLATINUM
AND
OPTIMA
SYSTEMS

 **DMS**
IMAGING

A DIVISION OF THE DMS GROUP

APELEM'S R/F SOLUTIONS

A COMPLETE RANGE OF SOLUTIONS FOR ALL TYPES OF BUDGET AND WORKFLOW

MAXIMUM FLEXIBILITY FOR A WIDE RANGE OF APPLICATIONS

IN TODAY'S MEDICAL IMAGING ENVIRONMENT, THE REMOTE-CONTROLLED TABLE IS THE IDEAL SOLUTION FOR EXPERTS LOOKING FOR A SYSTEM THAT OFFERS MAXIMUM FLEXIBILITY, A WIDE RANGE OF APPLICATIONS AND EXCELLENT IMAGE QUALITY. APELEM HAS STUDIED THE NOTION OF FLEXIBILITY AND PERFORMANCE, TO DEVELOP A RANGE OF SOLUTIONS THAT ENSURE BOTH THESE THINGS IN A HIGH-PERFORMING EFFICIENT PACKAGE THAT OPTIMIZES THE EXAMINATION EXPERIENCE.



THE PLATINUM SYSTEM

With its sleek design, all-in-one control console and mechanical ergonomics, the Platinum is THE remote-controlled table solution. Designed for a diagnostic experience that is as comfortable as possible for both patient and operator, the Platinum has been designed as a high-end solution for the most demanding workflows.

THE OPTIMA SYSTEM

The Optima was developed on the same platform as the Platinum and benefits from many of the same features and advanced technologies in a value-tier package. The main advantage of the platform effect is that servicing and applications training is exactly the same for both systems.

A COMPLETE SYSTEM WITH FLEXIBLE CONFIGURATIONS

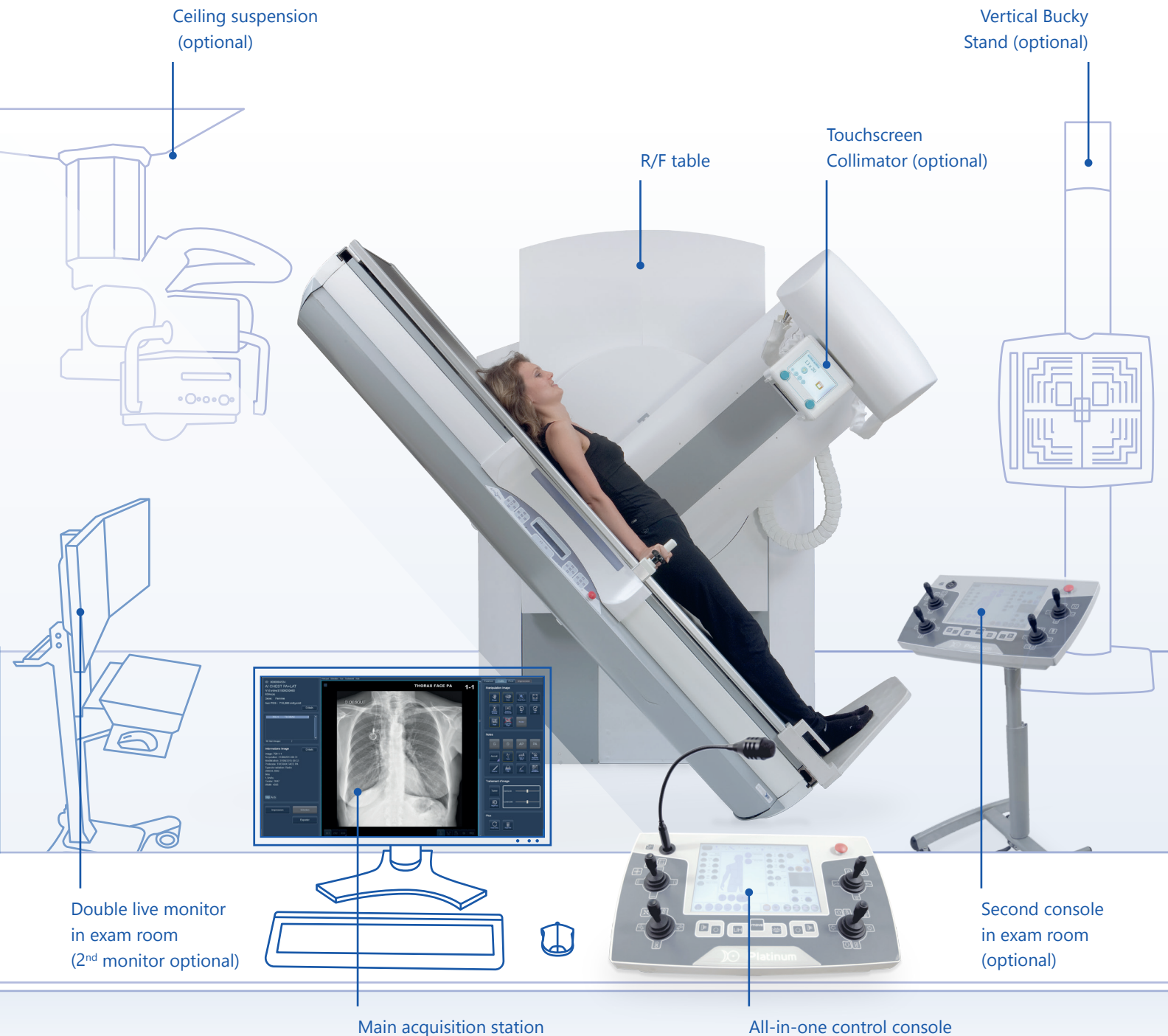

+OPTIONS

- Handsfree positioning pedal
- Infrared remote control
- Double pedal RAD / Fluoro in exam room
- Stitching
- Tomosynthesis (under development)
- Digital Substraction Angiography (DSA)

THE PLATINUM SYSTEM



PLATINUM

THE PLATINUM SYSTEM WAS DESIGNED TO PROVIDE MAXIMUM FLEXIBILITY FOR ALL TYPES OF EXAM ROOMS AND FOR ALL TYPES OF EXAMS. THE PLATINUM MAKES THE EXAMINATION EXPERIENCE AS CALM, COMFORTABLE AND NON STRESSFUL AS POSSIBLE. FEATURES LIKE THE AMBIENT LIGHT OR MP3 PLAYER HELP PUT PATIENTS AT EASE DURING ROUTINE EXAMS OR SPECIAL PROCEDURES.

ADAPTABILITY

The motorized tilting of the table at +/- 90° gives the Platinum the ability to easily integrate into any examination room.

PATIENT COMFORT

The Platinum can easily support a patient weighing up to 265 kg, with no movement limitations. The table top lowers to 48 cm to facilitate the patient loading. Full access around the table facilitates patient transfer.

FOCAL RANGE

With a continuous Source-To-Image-Distance (SID) of 110 to 180 cm, the Platinum allows a wide range of examinations, offering optimal accuracy for pulmonary and stitching examinations.

OPTIMAL PATIENT COVERAGE

Patient coverage is 201 cm.

As an option, longitudinal movement of the table top can further increase the patient coverage.

THE PLATINUM SYSTEM

COMFORT FOR MEDICAL OPERATOR

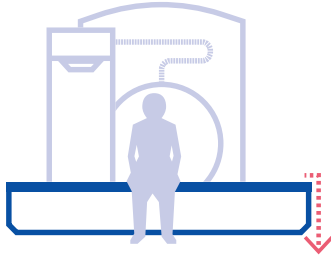
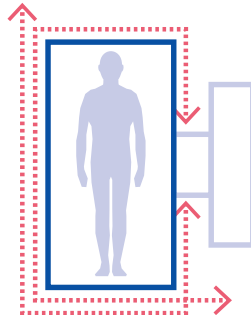
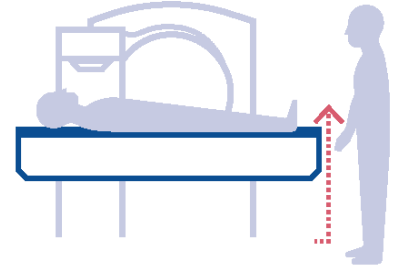

Table top lowers to 48cm for easy patient loading



Full access all around the table



Comfortable, adjustable working height up to 130cm

IMAGING EXCELLENCE

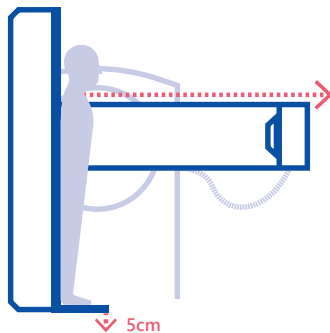

Source to image distance: up to 180cm

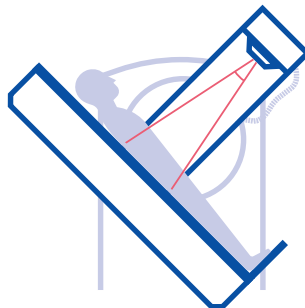

Patient coverage 201cm (+/- 50 cm with longitudinal movement as an option)

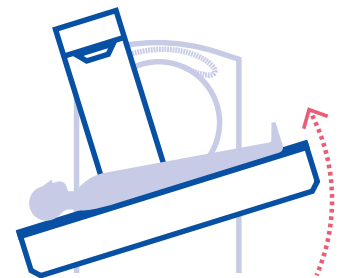

Programmable Trendelenburg position

ACCESSIBILITY FOR EVERY PATIENT

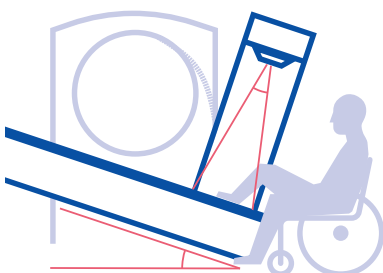

Easily adapts to mobility reduced patients

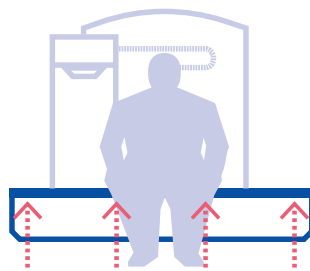

Supports the weight of a patient weighing up to 265 kg without any limitation

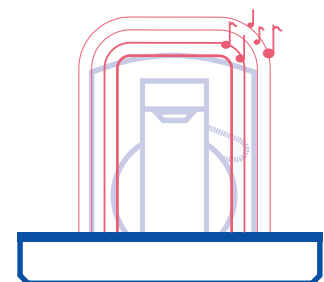

Ambient lights and MP3 player for a relaxing exam

THE OPTIMA SYSTEM



OPTIMA

BASED ON THE SAME TECHNOLOGY AS THE PLATINUM, THE OPTIMA HAS BEEN DESIGNED TO BE A ROBUST SOLUTION. THIS HIGH-PERFORMANCE TABLE USES THE HIGHEST TECHNOLOGY AVAILABLE ON A REMOTE-CONTROLLED TABLE AND OFFERS A COMFORTABLE DIAGNOSTIC EXPERIENCE FOR THE PATIENT. THE WIDE RANGE OF OPTIONS AVAILABLE MAKES IT ACCESSIBLE FOR DIFFERENT BUDGETS.

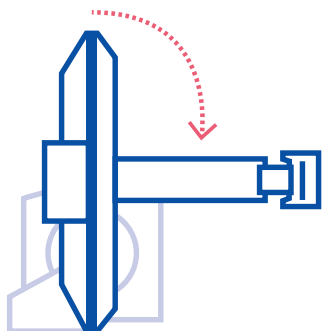

Innovative tilting movement to achieve a low fixed height: 79cm

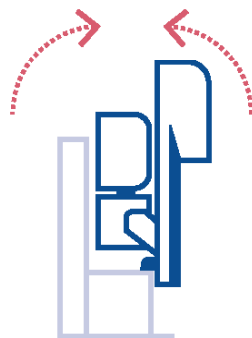

Innovative design for fast and easy transportation

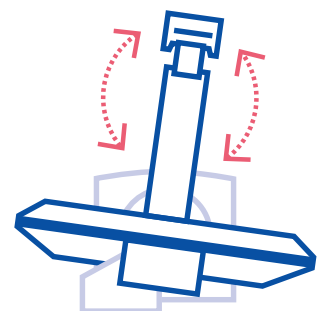

Fully motorized movements for an excellent workflow

WORKING DAILY WITH OUR SYSTEMS

DESIGNED TO PROVIDE AN OPTIMAL WORKFLOW AND TO ADAPT TO DIFFERENT WAYS OF WORKING.

1. SELECTION OF PATIENT IN THE WORKLIST

An unlimited number of APRs can be configured and stored in the acquisition system. Simply import a patient from the Worklist to automatically prepare all examination parameters, including generator constants, table position, additional filtration and collimation techniques.



2. CONTROL CONSOLE WITH FULL AUTO POSITION

Once the examination parameters have been selected on the acquisition station, simply press the "MOVE" button to position the table for the examination (table tilt, SID, tube angle, collimation, etc.). The settings are easily made using the joysticks. A camera integrated in the collimator allows the operator to position the patient with no dose and maintain continuous contact.



3. INNOVATIVE OPTIONS ADAPTED FOR ALL TYPES OF WORKFLOW

In addition to our control panel, innovative options have been developed to control the table's movements: a handsfree positioning pedal, a touchscreen collimator or an infrared remote control.



4. INSTANT ACCESS TO EXCEPTIONAL IMAGES

The image processing and post-processing tools are adapted to each procedure in order to give the best image by optimizing the dose.

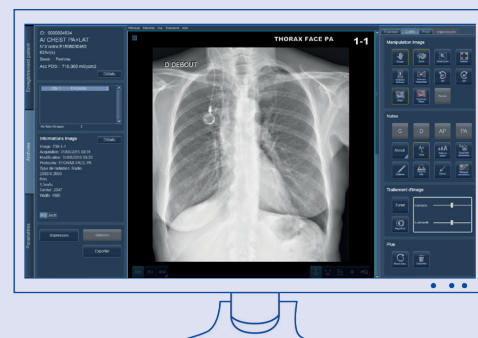

OPTIONS

	OPTIMA CONVENTIONAL	OPTIMA DRF	PLATINUM CONVENTIONAL	PLATINUM DRF
IMAGING TECHNOLOGY	Image intensifier	Flat panel dynamic detector	Image intensifier	Flat panel dynamic detector
VARIABLE HEIGHT	—	—	✓	✓
MINIMUM TABLE HEIGHT	79cm	79cm	60cm	48cm
ACCESS ALL AROUND THE PATIENT	—	—	✓	✓
MAXIMUM PATIENT WEIGHT WITHOUT ANY LIMITATION	200kg	200kg	265kg	265kg
PATIENT COVERAGE WITHOUT LONGITUDINAL OPTION	193cm	193cm	201cm	201cm
+1M LONGITUDINAL MOVEMENTS	Optional	Optional	Optional	Optional
SID	180cm	180cm	180cm	180cm
TILT RANGE	+90°/-30°	+90°/-30°	+90°/-90°	+90°/-90°
FULLY MOTORIZED MOVEMENTS	✓	✓	✓	✓
TOMOGRAPHY	✓	✓	✓	✓
PERIPHERAL ANGIOGRAPHY / DIGITAL SUBTRACTION ANGIOGRAPHY (DSA)	Optional	Optional	Optional	Optional
TOUCHSCREEN COLLIMATOR	Optional	Optional	Optional	Optional
HANDSFREE POSITIONING PEDAL	Optional	Optional	Optional	Optional
INFRARED REMOTE CONTROL	Optional	Optional	Optional	Optional
UROLOGY FUNCTION	—	—	Optional	Optional

PLATINUM & OPTIMA: MADE IN FRANCE INNOVATION



HEADQUARTERS > 393 rue Charles Lindbergh – 34130 Mauguio – FRANCE
FACTORY > Parc Scientifique G. Besse – 175 Allée Von Neumann – 30035 Nîmes Cedex 01 – FRANCE
PHONE > +33 4 66 29 09 07 – **FAX** > +33 4 67 50 49 09 – www.dms-imaging.com

These products are Class IIb medical devices manufactured by Apelem and bear the CE marking. They are certified in the European Union under the Medical Device Directive 93/42/EEC by SGS CE1639, exclusively for the indication of radiodiagnosis. Other non-medical uses ascribed to these devices are not within the scope of CE certification, and user should be aware product performance and/or safety has not been evaluated by SGS for those purposes. Read the operating instructions carefully. Photos are non-contractual. BrochureA_RFSOLUTIONS_02 05/2020